



# SERVICE MENU (PARAMETER LIST)



THIS MENU GIVES THE INSTALLER THE OPORTUNITY TO:

- 1 Activate and assign predefined external devices to relays (see figure below).
- 2 Adjust the unit to adverse conditions as well as configure its behaviour, and external devices connected to it.
- 3 Reset working hour counters.

## PASSWORD SERVICE MENU

 Consult your installer to access the Service Menu. The incorrect setting of this menu may imply errors in operation and loss of warranty.

## ELECTRONIC BOX ELECTRICAL CONNECTIONS

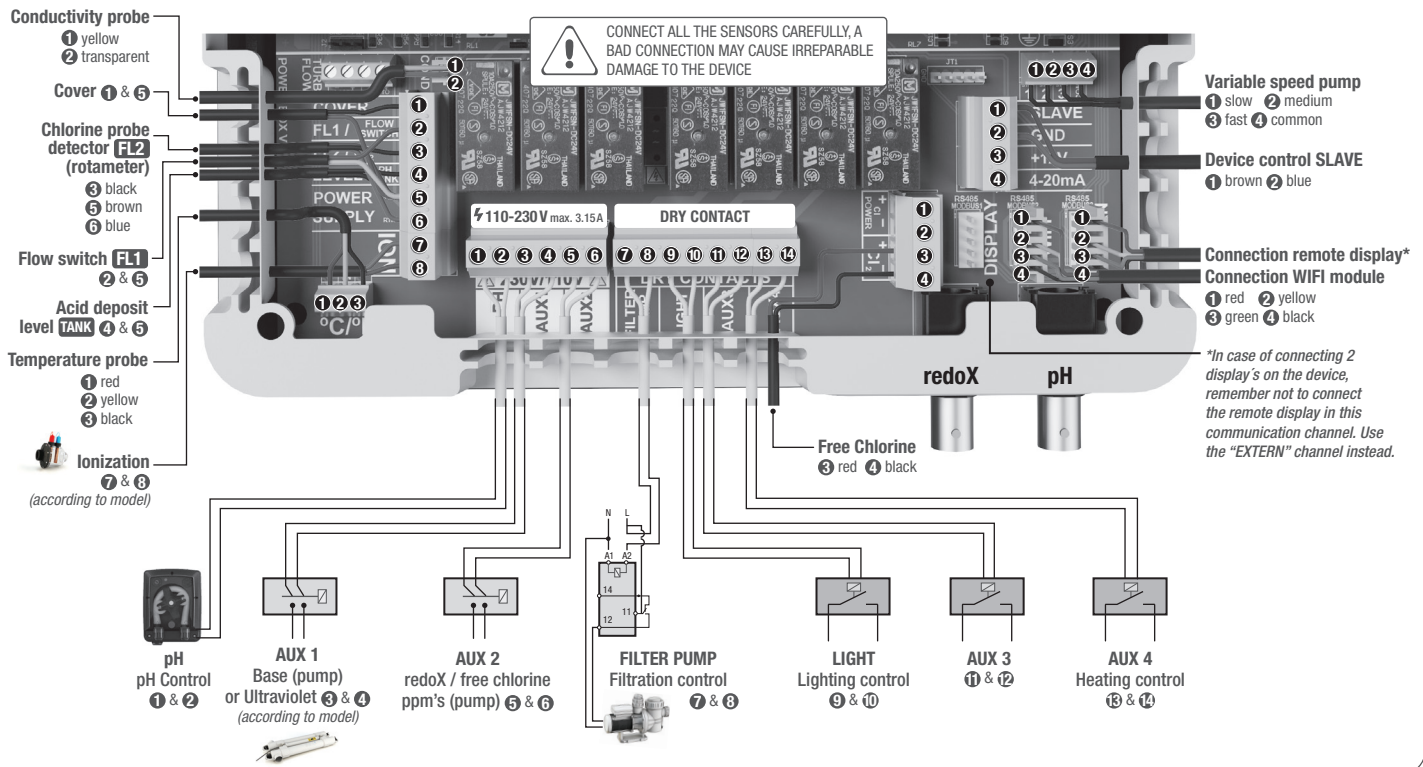

## SERVICE MENU

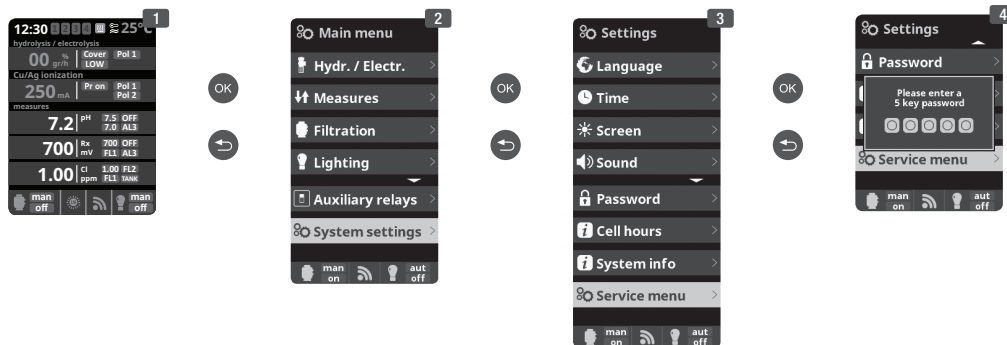

Accessing the Service Menu:

- 1: Main screen (according to model)
- 2: Select *System Settings*
- 3: Select *Service Menu*
- 4: Enter password: *Consult your installer to access the Service Menu. The incorrect setting of this menu may imply errors in operation and loss of warranty.*

## 1. RELAY CONFIGURATION

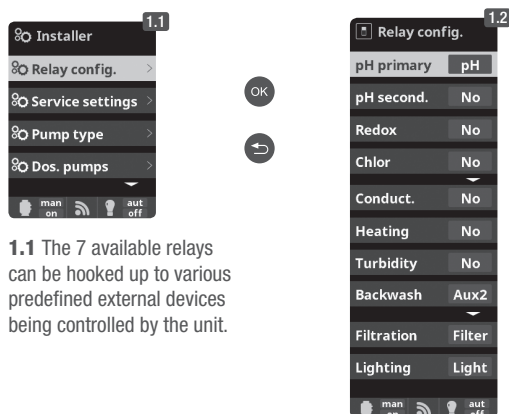

1.1 The 7 available relays can be hooked up to various predefined external devices being controlled by the unit.

1.2 The predefined functions are:\*  
 pH: Acid pH-pump.  
 Filter: Filtration pump.  
 Light: Pool lights.  
 AUX 1: Base pH-pump / UV light / Turbidity control.  
 AUX 2: Auxiliary disinfection dosing pump (as backup for the electrolysis cell) / Backwash valve / Conductivity.  
 AUX 4: Heat pump or other heating device.  
 \* Recommended relay settings.

**Nota:** "NO" will deactivate the predefined parameters and leave the relay available to be controlled by the different timers described under user menu "Auxiliary Relays". If you select an auxiliary relay (example AUX 1), it will activate the predefined external device on the corresponding relay

## 2. SERVICE SETTINGS

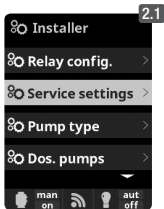

### 2.2 Parameters related to external devices:

Parameter 4, 8 and 9 – Configures auxiliary disinfection dosing pump on Relay AUX 2.

Parameter 10 – Configures the pH management (only acid dosing on Relay pH, acid and base dosing on Relay pH and AUX 1, only base dosing on Relay AUX 1).

Parameter 14 and 15 – Activates the temperature related functionalities.

Ajustes servicio	Range	Dimension	Standard factory value	Description
0 Ion pol 1 time RW Val: 10 000A	0...999	Minutes	10	Ionisation (Cu/Ag) positive polarity (only products including ionizer).
1 Ion pol 2 time RW Val: 10 000A	0...999	Minutes	10	Ionisation (Cu/Ag) positive polarity (only products including ionizer).
2 Ion dead time RW Val: 0 000A	0-5	Minutes	0	Dead time ionizer.
3 Flow mode select RW Val: 0 000A	0-1		1	<b>0 - FL1</b> Lack of water flow - It turns off only the cell. <b>1 - FL1</b> Lack of water flow - It turns off everything (cells, pumps, ionization...) <b>2 - FL2</b> Lack of water flow - It turns off only the cell. <b>3 - FL2</b> Lack of water flow - It turns off everything (cells, pumps, ionization...) <b>4 - FL1 &amp; FL2</b> If both detected no water flow, it turns off everything (cells, pumps, ionization...)
4 Hydrolysis mode RW Val: 0 000A	0-1-2		1	Configures stops/starts of the electrolysis/hydrolysis cell and auxiliary disinfection pump on Relay AUX 2 according to redoX reading. <b>0</b> - Without redoX/CL <sub>2</sub> (electrolysis/hydrolysis cell is always ON) - Auxiliary disinfection pump is controlled by redoX/free chlorine CL <sub>2</sub> . <b>1</b> - With redoX/CL <sub>2</sub> (redoX/free Cl set point stops/starts electrolysis/hydrolysis cell) - Auxiliary disinfection dosing pump is activated if redoX falls more than 2% lower than set point. <b>2</b> - With redoX/CL <sub>2</sub> (redoX set point stops/starts electrolysis/hydrolysis cell) - Auxiliary free chlorine dosing pumps are controlled via time delays of parameters 8 and 9.
5 Hidro pol 1 time RW Val: 30 001E	0...999	Minutes	300	Polarity 1 of electrolysis/hydrolysis cell.
6 Hidro pol 2 time RW Val: 30 001E	0...999	Minutes	300	Polarity 2 of electrolysis/hydrolysis cell.
7 Hidro dead time RW Val: 1 0001	0...5	Minutes	1	Dead time electrolysis/hydrolysis cell.
8 Redox/Cl relay wait time RW Val: 0 0000	0...999	Minutes	1	Corresponds to auxiliary disinfection dosing pump if parameter 4 is set to value 2. Time delay of auxiliary disinfection pump on Relay AUX 2.
9 Redox/Cl relay work time RW Val: 0 0000	0...999	Minutes	60	Corresponds to auxiliary disinfection dosing pump if parameter 4 is set to value 2. Maximum dosing time of auxiliary disinfection pump on Relay AUX 2.
10 pH setpoint mode RW Val: 0 0000	0-1-2		1	<b>0</b> - Acid and base are activated – controls 2 relays: relay pH and relay AUX 1. <b>1</b> - Only controls Acid: Relay pH. <b>2</b> - Only controls Base: Relay pH.
14 Show/use temperature RW Val: 1 0001	0-1		0	<b>0</b> - Temperature is not shown. <b>1</b> - Temperature is shown in display if the temperature probe is connected.
15 Heating RW Val: 1 0001	0-1		0	<b>0</b> - The Temperature probe does not control the heating relay. The relay AUX4 can be used as "auxiliary relay". <b>1</b> - The Temperature probe controls the heating relay. <b>2</b> - Maximum and minimum temperature controls the heating connected to Relay AUX 4, allowing the cooling and heating of the pool.

2.2

## 3. TYPE OF PUMP

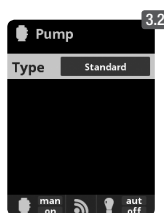
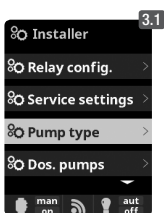

3.2 With the **plus/minus** keys, select the pump type connected to the system (the default is a standard pump type). The configuration allows the control of two different variable speed pumps (Variable Speed A or Variable Speed B). In case of a variable speed pump (A or B), establish the speed when the cover is closed, when the pool heating is connected and/or it controls a backwash filter (Besgo).

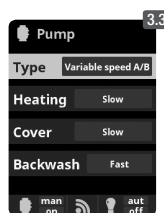

### 3.3 Variable Speed Pump A (Hayward® or similar):

During the filtration periods, the corresponding relay closes. The filtration pump opens and closes contacts depending on the speed:

- Common + 1 – Slow speed
- Common + 1 + 2 – Medium speed
- Common + 1 + 2 + 3 – Fast speed

Variable Speed Pump A B (Speck® or similar): During the filtration periods, the corresponding relay closes. It's necessary to connect a wire from the filtration relay to the common. The filtration pump opens and closes contacts depending on the speed:

- Common + 1 – Slow speed
- Common + 2 – Medium speed
- Common + 3 – Fast speed

## 4. DOSING PUMPS

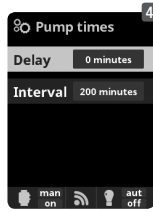
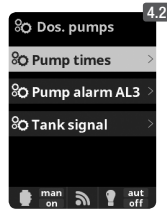
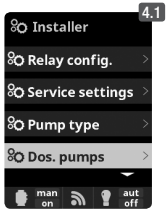

**4.3** Dosing pumps associated to pH, redoX and/or Chlorine allows the configuration of the following parameters:  
**Delay** – Delay time between detection of incorrect value and the start of dosing.  
**Interval** – Time interval until the dosing pump AL3 alarm is activated. At zero (0) the alarm is never activated. This alarm indicates that the dosing pump has been activated, but has not reached the desired level. **AL3** is shown on the main screen; in order to delete this message and reactivate the dosification, press

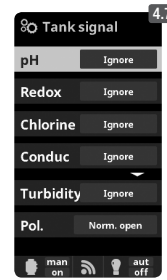

**4.5** It corresponds to the behavior of the system after AL3 activation:  
**Ignore** – AL3 is not shown in the display.  
**Inform** – After the selected interval, the AL3 alarm is displayed on the display.  
**Force stop** – After the selected interval, the AL3 alarm is displayed on the display and the dosing pump stops. To reset the alarm and the dosing pump, press

**4.7** You can associate the level sensor (TANK) to the pH or chlorine (rX). This menu corresponds to the behavior of the system after the TANK signal activation (acid deposit level TANK).  
**Ignore** – TANK is not shown in the display  
**Inform** – When the sensor detects that the level is low, the TANK alarm is displayed.  
**Force stop** – When the sensor detects that the level is low, the TANK alarm is displayed and the associated dosing pump stops.

## 5. EXTRA SETTINGS

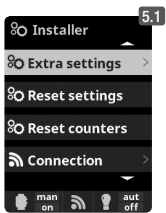

**5.2 Gas (0)** - The FL1 alarm is only activated by cell's gas sensor (external flow switch annulled).  
**Siempre ON (1)** - The FL1 alarm is never activated (invalidates cell's gas sensor and external flow switch);  
**Paddle (2)** - The FL1 alarm is activated by external flow switch (gas sensor annulled).  
**Paddle or gas (3)** - When both cell's gas sensor and external flow switch are connected, and either of them detects lack of flow, The FL1 alarm is activated. To connect the external flow switch use the FL1 terminal (see *Electronic Box Electrical Connections*).  
**Paddle + Gas (4)** - When both cell's gas sensor and external flow switch are connected, and both of them detects lack of flow, The FL1 alarm is activated. To connect the external flow switch use the FL1 terminal (see *Electronic Box Electrical Connections*).  
**Relay control through flow detection** - Manage the FL1 alarm deactivation in case of lack of flow. Recommended option for flocculant dosification or similar.

## 6. COUNTERS

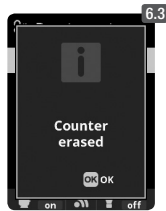
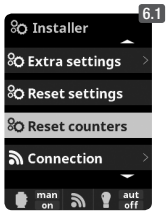

**6.2** Reset counters: There are two levels of working hours counters which log the working hours of the components and devices.  
 In this service menu the installer can reset the working hour counters on the first level (for example when a new cell is installed).  
 The second level of the working hour counters can only be accessed by the factory.

## 7. CONNECTION

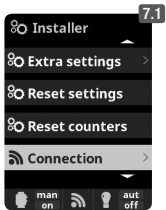

**7.2** Comunicación (Conexión): Used for the configuration of more than 2 user interfaces.  
 For normal operation of the system, keep the value to 1 for this parameter.

## 8. WEB IP

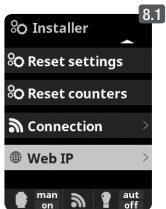

**8.2** Server control and connection port in case there is WIFI Module connected to the system.  
 For the proper functioning of the system, do not change the default values unless you receive a notice from your provider.